

SECTION **STC**

STEERING CONTROL SYSTEM

A
B
C
D
E
F
G
H
I
J
K
L
M
N
O
P

CONTENTS

<p>BASIC INSPECTION 2</p> <p>DIAGNOSIS AND REPAIR WORK FLOW 2</p> <p style="padding-left: 20px;">Work Flow2</p> <p>SYSTEM DESCRIPTION 3</p> <p>EPS SYSTEM 3</p> <p style="padding-left: 20px;">System Diagram3</p> <p style="padding-left: 20px;">System Description3</p> <p style="padding-left: 20px;">Component Parts Location5</p> <p style="padding-left: 20px;">Component Description5</p> <p>DTC/CIRCUIT DIAGNOSIS 6</p> <p>POWER SUPPLY AND GROUND CIRCUIT 6</p> <p style="padding-left: 20px;">Description6</p> <p style="padding-left: 20px;">Diagnosis Procedure6</p> <p>POWER STEERING SOLENOID VALVE 7</p> <p style="padding-left: 20px;">Description7</p> <p style="padding-left: 20px;">Component Function Check7</p> <p style="padding-left: 20px;">Diagnosis Procedure7</p> <p style="padding-left: 20px;">Component Inspection8</p> <p>ENGINE SPEED SIGNAL CIRCUIT 9</p> <p style="padding-left: 20px;">Description9</p> <p style="padding-left: 20px;">Diagnosis Procedure9</p> <p>VEHICLE SPEED SIGNAL CIRCUIT11</p> <p style="padding-left: 20px;">Description11</p> <p style="padding-left: 20px;">Diagnosis Procedure11</p>	<p>ECU DIAGNOSIS INFORMATION13</p> <p>POWER STEERING CONTROL UNIT13</p> <p style="padding-left: 20px;">Reference Value13</p> <p style="padding-left: 20px;">Wiring Diagram - ELECTRONICALLY CONTROLLED POWER STEERING SYSTEM -15</p> <p style="padding-left: 20px;">Fail-Safe18</p> <p>SYMPTOM DIAGNOSIS20</p> <p>UNBALANCE STEERING WHEEL TURNING FORCE (TORQUE VARIATION)20</p> <p style="padding-left: 20px;">Description20</p> <p style="padding-left: 20px;">Diagnosis Procedure20</p> <p>PRECAUTION21</p> <p>PRECAUTIONS21</p> <p style="padding-left: 20px;">Precaution for Supplemental Restraint System (SRS) "AIR BAG" and "SEAT BELT PRE-TENSIONER"21</p> <p style="padding-left: 20px;">Precautions Necessary for Steering Wheel Rotation After Battery Disconnection21</p> <p style="padding-left: 20px;">Service Procedure Precautions for Models with a Pop-up Roll Bar22</p> <p style="padding-left: 20px;">Precaution for Battery Service22</p> <p>REMOVAL AND INSTALLATION23</p> <p>POWER STEERING CONTROL UNIT23</p> <p style="padding-left: 20px;">Removal and Installation23</p>
---	---

STC

DIAGNOSIS AND REPAIR WORK FLOW

< BASIC INSPECTION >

BASIC INSPECTION

DIAGNOSIS AND REPAIR WORK FLOW

Work Flow

INFOID:000000006469982

DETAILED FLOW

1. COLLECT THE INFORMATION FROM THE CUSTOMER

It is also important to clarify customer complaints before inspection. First of all, reproduce symptoms and understand them fully. Ask customer about his/her complaints carefully. In some cases, it is necessary to check symptoms by driving vehicle with customer.

CAUTION:

Customers are not professional. It is dangerous to make an easy guess like “maybe the customer means that...,” or “maybe the customer mentions this symptom”.

>> GO TO 2.

2. CHECK THE STATUS

1. Power steering fluid leakage and check the power steering fluid level. Refer to [ST-9, "Inspection"](#).
2. Check the drive belt tension. Refer to [EM-13, "Checking"](#).
3. Check the power steering gear for damages, cracks and fluid leakage. Refer to [ST-30, "Inspection"](#).
4. Check the relief oil pressure. Refer to [ST-36, "EXCEPT FOR SPORT MODELS : Inspection"](#) (Except for sport models), [ST-41, "SPORT MODELS : Inspection"](#) (Sport models).

>> GO TO 3.

3. DIAGNOSIS CHART BY SYMPTOM

Perform the diagnosis by symptom. Refer to [STC-20, "Diagnosis Procedure"](#).

>> GO TO 4.

4. FINAL CHECK

Check the input/output standard values for the power steering control unit.

Are the power steering control unit input/output values within standard ranges respectively?

- YES >> INSPECTION END
NO >> GO TO 2.

EPS SYSTEM

< SYSTEM DESCRIPTION >

SYSTEM DESCRIPTION

EPS SYSTEM

System Diagram

INFOID:000000006469983

CONTROL DIAGRAM

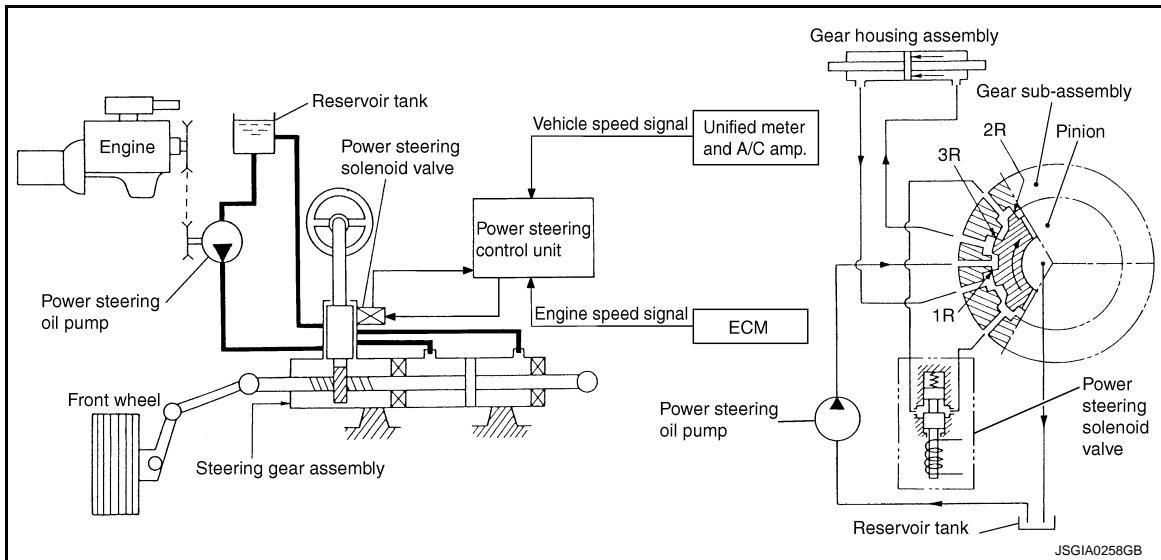

CROSS-SECTIONAL VIEW

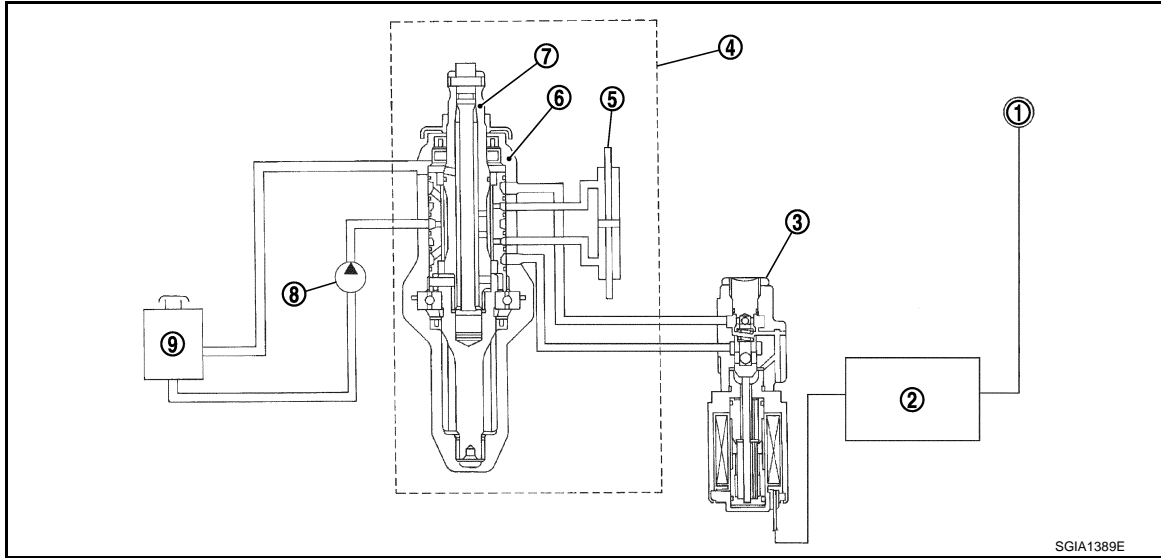

- | | | |
|-------------------------------|--------------------------------|----------------------------------|
| 1. Unified meter and A/C amp. | 2. Power steering control unit | 3. Power steering solenoid valve |
| 4. Steering gear assembly | 5. Gear housing assembly | 6. Gear sub-assembly |
| 7. Pinion | 8. Power steering oil pump | 9. Reservoir tank |

System Description

INFOID:000000006469984

- The EPS system controls the power steering solenoid valve through the power steering control unit.

EPS SYSTEM

< SYSTEM DESCRIPTION >

- The valve driving voltage to control the power steering solenoid valve varies according to the vehicle speed.

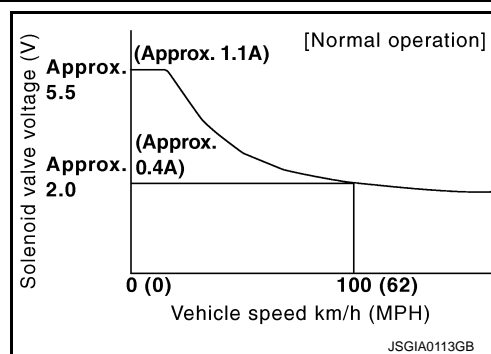

OPERATION PRINCIPLE

During Parking (When Turning The Steering Wheel To The Right.)

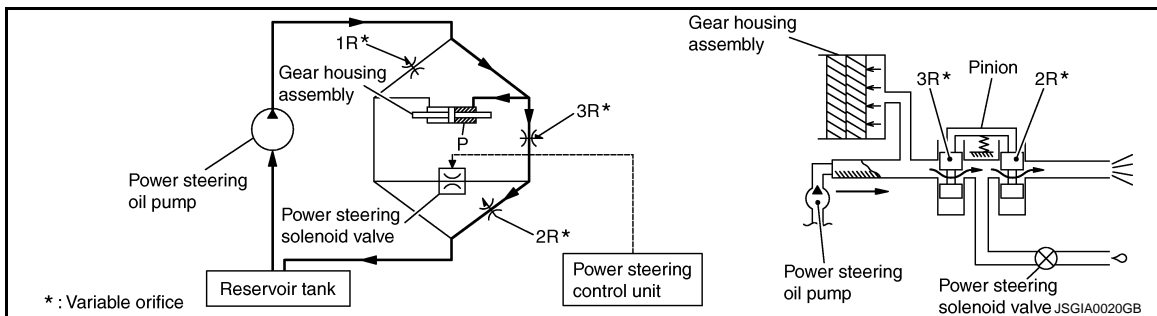

- Power steering solenoid valve is closed while a vehicle is stopped.
- Pinion “1R”, “2R” and “3R” are closed depending on steering torque of steering wheel.
- Oil pressure “P” in the gear housing assembly is the sum of oil pressures occurred in “2R” and “3R”. This results in a light steering force because of high pressure.

During High-speed Operation

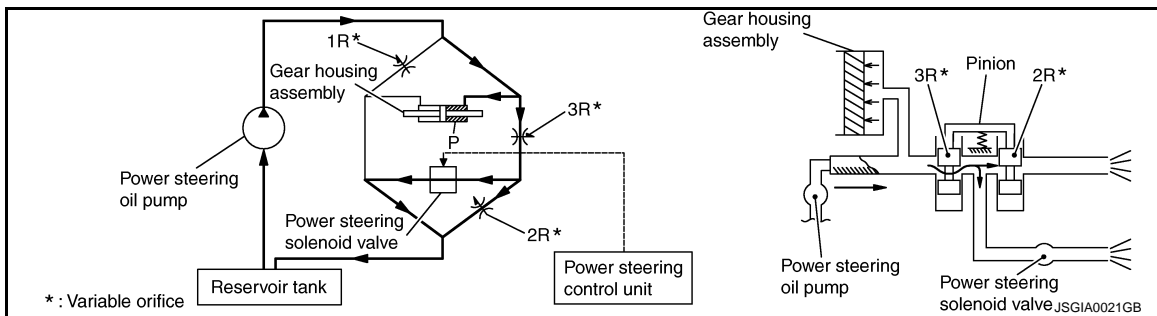

- Power steering solenoid valve is opened during high-speed operation.
- Pinion “1R”, “2R” and “3R” are closed depending on steering torque of steering wheel.
- Oil pressure “2R” does not occur because the power steering solenoid valve is on full throttle.
- Oil pressure “P” in the gear housing assembly includes only oil pressure occurred in “3R” and results in a heavy steering force.

EPS SYSTEM

< SYSTEM DESCRIPTION >

Component Parts Location

INFOID:000000006469985

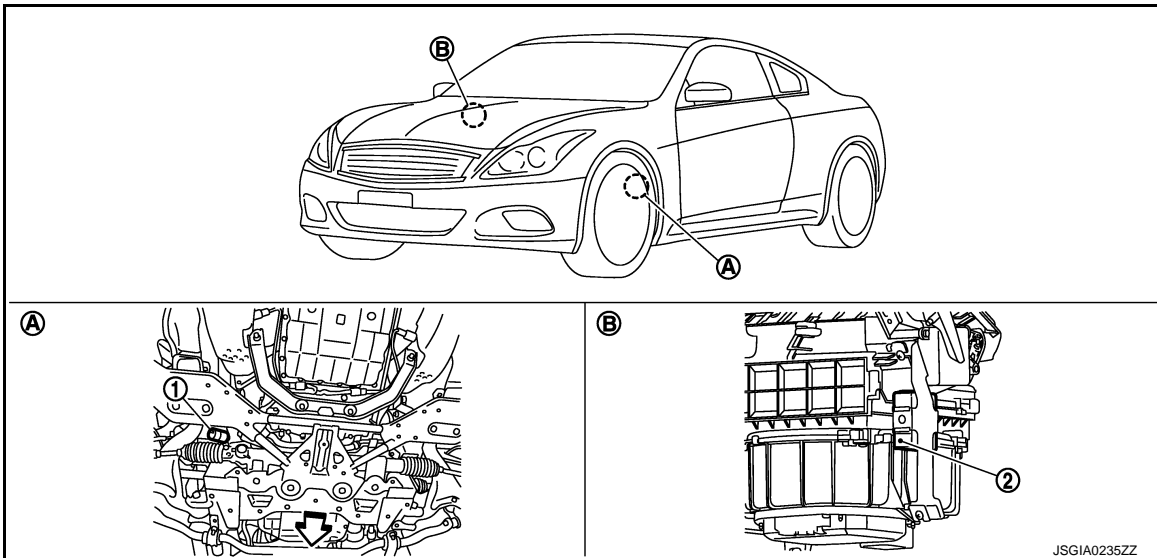

- 1. Power steering solenoid valve
- 2. Power steering control unit
- A. Steering gear assembly
- B. Glove box assembly removed

⇐: Vehicle front

Component Description

INFOID:000000006469986

Component parts	Reference/Function
Power steering control unit	<ul style="list-style-type: none"> • Signals from various sensors control the driving voltage to the power steering solenoid valve. • The power steering control unit controls the driving voltage to the power steering solenoid valve for maintaining the power steering assist force when the fail-safe function is activated. (The engine speed signals control EPS system if any vehicle speed signal error is detected.)
Unified meter and A/C amp.	STC-11. "Description"
ECM	STC-9. "Description"
Power steering solenoid valve	STC-7. "Description"

POWER SUPPLY AND GROUND CIRCUIT

< DTC/CIRCUIT DIAGNOSIS >

DTC/CIRCUIT DIAGNOSIS

POWER SUPPLY AND GROUND CIRCUIT

Description

INFOID:000000006469987

Power supply to EPS system

Diagnosis Procedure

INFOID:000000006469988

1. CHECK POWER SUPPLY

1. Turn the ignition switch OFF.
2. Disconnect power steering control unit harness connector.
3. Check the voltage between power steering control unit harness connector and ground.

Power steering control unit		—	Voltage
Connector	Terminal		
M108	3	Ground	0 V

4. Turn the ignition switch ON.
CAUTION:
Never start the engine.
5. Check the voltage between power steering control unit harness connector and ground.

Power steering control unit		—	Voltage
Connector	Terminal		
M108	3	Ground	Battery voltage

Is the inspection result normal?

YES >> GO TO 2.

NO >> Check the following. If any items are damaged, repair or replace damaged parts.

- 10A fuse (#45) open
- Harness for short or open between ignition switch and power steering control unit harness connector No. 3 terminal.
- Ignition switch. Refer to [PCS-67, "Component Inspection"](#).

2. CHECK GROUND CIRCUIT

1. Turn the ignition switch OFF.
2. Check the continuity between power steering control unit harness connector and ground.

Power steering control unit		—	Continuity
Connector	Terminal		
M108	6	Ground	Existed

Is the inspection result normal?

YES >> GO TO 3.

NO >> Repair or replace error-detected parts.

3. CHECK TERMINALS AND HARNESS CONNECTORS

Check the power steering control unit pin terminals for damage or loose connection with harness connector.

Is the inspection result normal?

YES >> INSPECTION END

NO >> Repair or replace error-detected parts.

POWER STEERING SOLENOID VALVE

< DTC/CIRCUIT DIAGNOSIS >

POWER STEERING SOLENOID VALVE

Description

INFOID:000000006469989

Power steering solenoid valve controls the power steering oil pressure in the gear housing assembly.

Component Function Check

INFOID:000000006469990

1.CHECK POWER STEERING SOLENOID VALVE OPERATION

Check changes in steering force from a halt condition to high-speed driving.

Is the inspection result normal?

YES >> INSPECTION END

NO >> Check the power steering solenoid valve. Refer to [STC-7, "Diagnosis Procedure"](#).

Diagnosis Procedure

INFOID:000000006469991

1.CHECK POWER STEERING SOLENOID VALVE SIGNAL

1. Turn the ignition switch OFF.
2. Check the voltage between power steering control unit harness connector and ground.

Power steering control unit		—	Condition	Voltage (Approx.)
Connector	Terminal			
M108	1	Ground	Vehicle speed: 0 km/h (0 MPH) (Engine is running)	4.4 – 6.6 V
			Vehicle speed: 100 km/h (62 MPH)	2.4 – 3.6 V

Is the inspection result normal?

YES >> GO TO 4.

NO >> GO TO 2.

2.CHECK HARNESS BETWEEN POWER STEERING SOLENOID VALVE AND POWER STEERING CONTROL UNIT

1. Turn the ignition switch OFF.
2. Disconnect power steering solenoid valve harness connector.
3. Disconnect power steering control unit harness connector.
4. Check the continuity between power steering solenoid valve harness connector and the power steering control unit harness connector.

Power steering solenoid valve		Power steering control unit		Continuity
Connector	Terminal	Connector	Terminal	
F45	1	M108	1	Existed
	2		5	Existed

5. Check the continuity between power steering control unit harness connector and ground.

Power steering control unit		—	Continuity
Connector	Terminal		
M108	1	Ground	Not existed
	5		

Is the inspection result normal?

YES >> GO TO 3.

NO >> Repair or replace error-detected parts.

3.CHECK POWER STEERING SOLENOID VALVE

Check the power steering solenoid valve. Refer to [STC-8, "Component Inspection"](#).

POWER STEERING SOLENOID VALVE

< DTC/CIRCUIT DIAGNOSIS >

Is the inspection result normal?

YES >> GO TO 4.

NO >> Replace gear-sub assembly. Refer to [ST-24, "Exploded View"](#).

4. CHECK TERMINALS AND HARNESS CONNECTORS

- Check the power steering control unit pin terminals for damage or loose connection with harness connector.
- Check the power steering solenoid valve pin terminals for damage or loose connection with harness connector.

Is the inspection result normal?

YES >> Replace power steering control unit. Refer to [STC-23, "Removal and Installation"](#).

NO >> Repair or replace error-detected parts.

Component Inspection

INFOID:000000006469992

1. CHECK POWER STEERING SOLENOID VALVE

1. Turn the ignition switch OFF.
2. Disconnect power steering solenoid valve harness connector.
3. Check resistance between power steering solenoid valve connector terminals.

Power steering solenoid valve		Resistance (Approx.)
Terminal		
1	2	4 – 6 Ω

4. Check power steering solenoid valve by listening for its operation sound while applying battery voltage to power steering solenoid valve connector F45 terminals 1 (positive) and 2 (negative).

Is the inspection result normal?

YES >> INSPECTION END

NO >> Replace gear-sub assembly. Refer to [ST-24, "Exploded View"](#).

ENGINE SPEED SIGNAL CIRCUIT

< DTC/CIRCUIT DIAGNOSIS >

ENGINE SPEED SIGNAL CIRCUIT

Description

INFOID:000000006469993

ECM sends engine speed signal to power steering control unit.

Diagnosis Procedure

INFOID:000000006469994

1. PERFORM ECM SELF-DIAGNOSIS

With CONSULT-III

1. Turn the ignition switch ON.

CAUTION:

Never start the engine

2. Perform "ENGINE" self-diagnosis. Refer to [EC-138, "CONSULT-III Function"](#).

Is any DTC detected?

- YES >> Check the DTC.
NO >> GO TO 2.

2. CHECK HARNESS BETWEEN ECM AND POWER STEERING CONTROL UNIT

1. Turn the ignition switch OFF.
2. Disconnect ECM harness connectors.
3. Disconnect power steering control unit harness connector.
4. Check the continuity between ECM harness connector and power steering control unit harness connector.

ECM		Power steering control unit		Continuity
Connector	Terminal	Connector	Terminal	
M107	110	M108	10	Existed

5. Check the continuity between power steering control unit harness connector and ground.

Power steering control unit		—	Continuity
Connector	Terminal		
M108	10	Ground	Not existed

Is the inspection result normal?

- YES >> GO TO 3.
NO >> Repair or replace error-detected parts.

3. CHECK ENGINE SPEED SIGNAL (1)

1. Connect ECM harness connectors.
2. Turn the ignition switch ON.
3. Check the signal between ECM harness connector and ground with oscilloscope.

A
B
C
D
E
F
H
I
J
K
L
M
N
O
P

STC

ENGINE SPEED SIGNAL CIRCUIT

< DTC/CIRCUIT DIAGNOSIS >

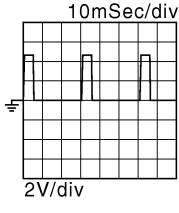
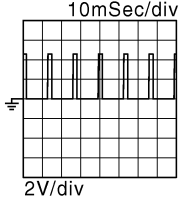
ECM		—	Condition	Voltage (Approx.)
Connector	Terminal			
M107	110	Ground	Engine is running • Warm-up condition • Idle speed	
			Engine is running • Warm-up condition • Engine speed: Approx. 2,000 rpm	

Is the inspection result normal?

YES >> GO TO 4.

NO >> Replace ECM. Refer to [EC-17, "ADDITIONAL SERVICE WHEN REPLACING CONTROL UNIT \(ECM\) : Description"](#).

4. CHECK ENGINE SPEED SIGNAL (2)

- Turn the ignition switch OFF.
- Connect power steering control unit harness connector.
- Check the signal between power steering control unit harness connector and ground with oscilloscope.

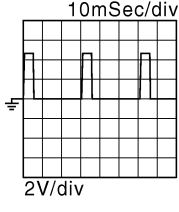
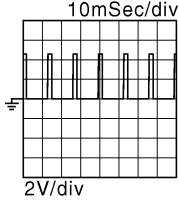
Power steering control unit		—	Condition	Voltage (Approx.)
Connector	Terminal			
M108	10	Ground	Engine is running • Warm-up condition • Idle speed	
			Engine is running • Warm-up condition • Engine speed: Approx. 2,000 rpm	

Is the inspection result normal?

YES >> GO TO 5.

NO >> Replace power steering control unit. Refer to [STC-23, "Removal and Installation"](#).

5. CHECK TERMINALS AND HARNESS CONNECTORS

- Check the power steering control unit pin terminals for damage or loose connection with harness connector.
- Check the ECM pin terminals for damage or loose connection with harness connector.

Is the inspection result normal?

YES >> INSPECTION END

NO >> Repair or replace error-detected parts.

VEHICLE SPEED SIGNAL CIRCUIT

< DTC/CIRCUIT DIAGNOSIS >

VEHICLE SPEED SIGNAL CIRCUIT

Description

INFOID:000000006469995

Unified meter and A/C amp. sends vehicle speed signal to power steering control unit.

Diagnosis Procedure

INFOID:000000006469996

1. PERFORM UNIFIED METER AND A/C AMP. SELF-DIAGNOSIS

With CONSULT-III

1. Turn the ignition switch ON.
2. Perform "METER/M&A" self-diagnosis. Refer to [MWI-36, "CONSULT-III Function \(METER/M&A\)"](#).

Is any DTC detected?

- YES >> Check the DTC.
NO >> GO TO 2.

2. CHECK HARNESS BETWEEN UNIFIED METER AND A/C AMP. AND POWER STEERING CONTROL UNIT

1. Turn the ignition switch OFF.
2. Disconnect unified meter and A/C amp. harness connector.
3. Disconnect power steering control unit harness connector.
4. Check the continuity between unified meter and A/C amp. harness connector and power steering control unit harness connector.

Unified meter and A/C amp.		Power steering control unit		Continuity
Connector	Terminal	Connector	Terminal	
M66	8	M108	8	Existed

5. Check the continuity between power steering control unit harness connector and ground.

Power steering control unit		—	Continuity
Connector	Terminal		
M108	8	Ground	Not existed

Is the inspection result normal?

- YES >> GO TO 3.
NO >> Repair or replace error-detected parts.

3. CHECK VEHICLE SPEED SIGNAL (1)

1. Connect unified meter and A/C amp. harness connector.
2. Check the unified meter and A/C amp. input/output standard values. Refer to [MWI-82, "Reference Value"](#).

Is the inspection result normal?

- YES >> GO TO 4.
NO >> Replace unified meter and A/C amp. Refer to [MWI-132, "Exploded View"](#).

4. CHECK VEHICLE SPEED SIGNAL (2)

1. Turn the ignition switch OFF.
2. Connect power steering control unit harness connector.
3. Check the signal between power steering control unit harness connector and ground with oscilloscope.

VEHICLE SPEED SIGNAL CIRCUIT

< DTC/CIRCUIT DIAGNOSIS >

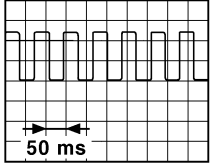
Power steering control unit		—	Condition	Voltage (Approx.)
Connector	Terminal			
M108	8	Ground	Vehicle speed: 40 km/h (25 MPH) CAUTION: Check air pressure of tire under standard condition.	NOTE: The maximum voltage varies depending on the specification (destination unit). 

JSNIA0015GB

Is the inspection result normal?

YES >> GO TO 5.

NO >> Replace power steering control unit. Refer to [STC-23, "Removal and Installation"](#).

5. CHECK TERMINALS AND HARNESS CONNECTORS

- Check the power steering control unit pin terminals for damage or loose connection with harness connector.
- Check the unified meter and A/C amp. pin terminals for damage or loose connection with harness connector.

Is the inspection result normal?

YES >> INSPECTION END

NO >> Repair or replace error-detected parts.

POWER STEERING CONTROL UNIT

< ECU DIAGNOSIS INFORMATION >

ECU DIAGNOSIS INFORMATION

POWER STEERING CONTROL UNIT

Reference Value

INFOID:000000006469997

TERMINAL LAYOUT

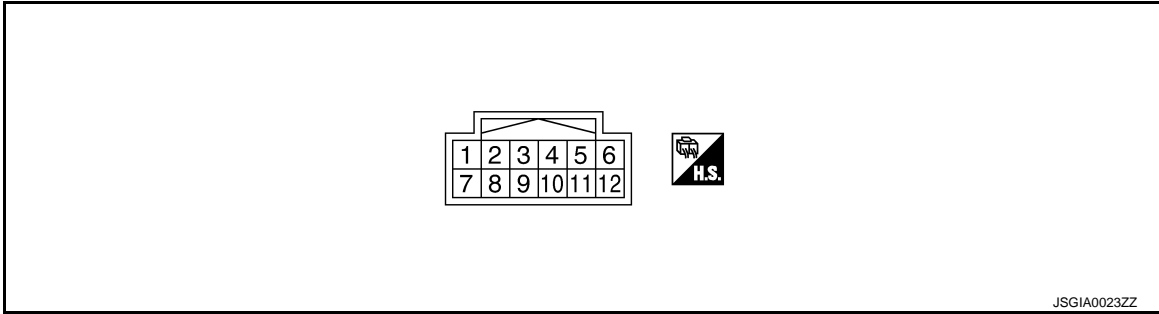

PHYSICAL VALUES

Terminal No. (Wire color)		Description		Condition	Value (Approx.)
+	-	Signal name	Input/ Output		
1 (LG)	Ground	Power steering solenoid valve control voltage	Output	Vehicle speed: 0 km/h (0 MPH) (Engine is running)	4.4 – 6.6 V
				Vehicle speed: 100 km/h (62 MPH)	2.4 – 3.6 V
3 (G)	Ground	Ignition switch power supply	Input	Ignition switch: ON	Battery voltage
				Ignition switch: OFF	0 V
5 (GR)	Ground	Power steering solenoid valve ground	—	Always	0 V
6 (B)	Ground	Ground	—	Always	0 V
8 (L)	Ground	Vehicle speed signal	Input	Vehicle speed: 40 km/h (25 MPH) CAUTION: Check air pressure of tire under standard condition.	<p>NOTE: The maximum voltage varies de- pending on the specification (destination unit).</p> <p>JSNIA0015GB</p>

A
B
C
D
E
F
STC
H
I
J
K
L
M
N
O
P

POWER STEERING CONTROL UNIT

< ECU DIAGNOSIS INFORMATION >

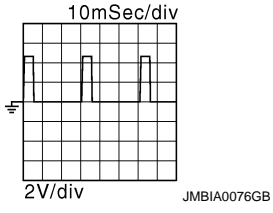
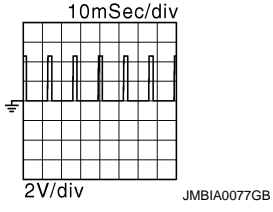
Terminal No. (Wire color)		Description		Condition	Value (Approx.)
+	-	Signal name	Input/ Output		
10 (BR)	Ground	Engine speed signal	Input	Engine is running <ul style="list-style-type: none"> • Warm-up condition • Idle speed 	
				Engine is running <ul style="list-style-type: none"> • Warm-up condition • Engine speed: Approx. 2,000 rpm 	

CAUTION:

When using circuit tester or oscilloscope to measure voltage for inspection, never forcibly extend any connector terminals.

POWER STEERING CONTROL UNIT

< ECU DIAGNOSIS INFORMATION >

Wiring Diagram - ELECTRONICALLY CONTROLLED POWER STEERING SYSTEM -

INFOID:000000006469998

ELECTRONICALLY CONTROLLED POWER STEERING SYSTEM

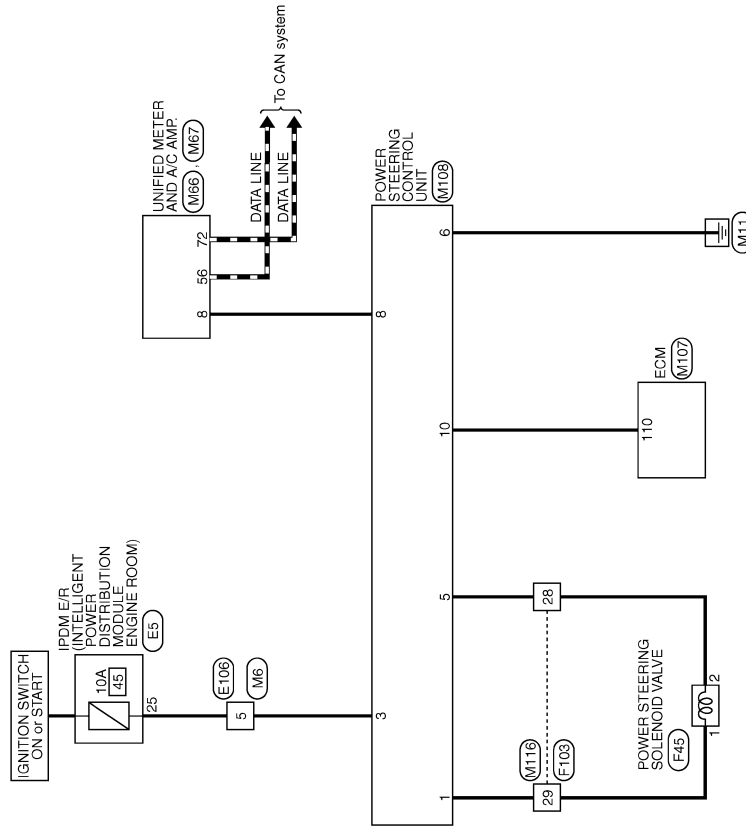

2009/11/10

JCGWM0328GB

A
B
C
D
E
F
G
H
I
J
K
L
M
N
O
P

STC

POWER STEERING CONTROL UNIT

< ECU DIAGNOSIS INFORMATION >

ELECTRONICALLY CONTROLLED POWER STEERING SYSTEM

Connector No.	E5
Connector Name	ENGINE ROOM INTELLIGENT POWER DISTRIBUTION MODULE
Connector Type	TH20FW-CS12-M4-1V

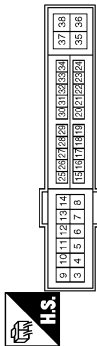

Terminal No.	Color of Wire	Signal Name [Specification]
4	V	
5	SB	
6	R	
7	BR	
11	B/W	
12	Y	
13	LG	
14	W	
16	SB	
17	R	
18	BR	
19	B/W	
20	Y	
21	LG	
22	W	
23	G	
26	R	
27	BG	
28	L	
30	GR	
32	P	
33	P	
36	G	

Connector No.	E106
Connector Name	WIRE TO WIRE
Connector Type	TH80FW-CS16-TM4

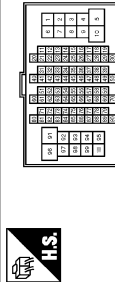

Terminal No.	Color of Wire	Signal Name [Specification]
1	GR	
3	BG	
4	B/W	
5	G	
6	BG	

7	LG	
8	G	
9	R	
10	W	
11	V	
12	R	
13	L	
14	GR	
15	P	
16	W	
17	V	
18	BG	
19	GR	
20	LG	
30	R	
31	L	
32	BG	
33	P	
34	V	
35	BR	
36	W	
37	Y	
38	R	
39	B	
40	G	
41	W	
42	LG	
43	SB	
44	GR	
45	BG	
46	LG	
47	V	
48	P	
49	L	
59	B	
66	LG	
67	SB	
68	R	
69	W	
70	G	
80	W	
81	P	
82	G	
83	V	
84	L	
85	BG	
86	LG	
87	Y	
88	GR	
89	W	
90	W	
91	G	

92	B	
93	GR	
94	L	
95	Y	
97	BR	
98	SHIELD	
99	L	
100	P	

Connector No.	F45
Connector Name	POWER STEERING SOLENOID VALVE
Connector Type	RS0ZFBR-DGY

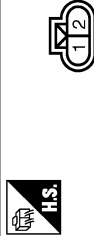

Terminal No.	Color of Wire	Signal Name [Specification]
1	LG	
2	B	

Connector No.	F103
Connector Name	WIRE TO WIRE
Connector Type	TK36FW-NS10

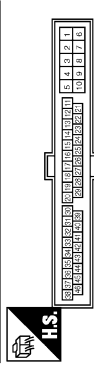

Terminal No.	Color of Wire	Signal Name [Specification]
2	G	
3	W	
4	R	
5	B	
9	Y	
10	GR	
19	O	
20	Y	
28	B	
29	LG	

POWER STEERING CONTROL UNIT

< ECU DIAGNOSIS INFORMATION >

ELECTRONICALLY CONTROLLED POWER STEERING SYSTEM

Connector No.	M6
Connector Name	WIRE TO WIRE
Connector Type	TH80M/2S16-TM4

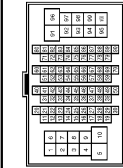

Terminal No.	Color of Wire	Signal Name [Specification]
1	BG	
2	R	
3	G	
4	R	
5	G	
6	BR	
7	BR	
8	Y	
9	R	
10	W	
11	GR	
12	R	
13	L	
14	G	
15	P	
16	W	
17	BR	
18	V	
19	BG	
20	L	
30	R	
31	L	
32	Y	
33	GR	
34	P	
35	BR	
36	BR	
37	Y	
38	LG	
39	SB	
40	G	
41	W	
42	LG	
43	P	
44	GR	- [With A/T]
44	R	- [With M/T]
45	BG	
46	G	
47	P	

48	P	
49	L	
50	B	
51	Y	
52	G	
53	R	
54	W	
55	GR	
56	W	
57	G	
58	SB	
59	W	
60	SB	
61	R	
62	V	
63	W	
64	L	
65	BG	
66	G	
67	V	
68	B	
69	SB	
70	G	
71	W	
72	SB	
73	R	
74	R	
75	V	
76	W	
77	P	
78	SHIELD	
79	V	
80	SB	

Connector No.	M66
Connector Name	UNIFIED METER AND A/C AMP.
Connector Type	TH40PV-NH



Terminal No.	Color of Wire	Signal Name [Specification]
4	G	STOP LAMP SWITCH
5	L	MANUAL MODE SHIFTER UP SIGNAL
6	BG	PADDLE SHIFTER UP SIGNAL
7	GR	COMMUNICATION SIGNAL (AMP->METER)
8	L	VEHICLE SPEED (2-PULSE)
9	SB	SEAT BELT BUCKLE SWITCH SIGNAL (DRIVER SIDE)
10	W	MANUAL MODE SIGNAL
11	G	NON-MANUAL MODE SIGNAL

14	SB	COMMUNICATION SIGNAL (LCD->AMP.)
20	G	IGN ON / OFF SIGNAL
23	V	MANUAL MODE SHIFTER DOWN SIGNAL
26	G	PADDLE SHIFTER DOWN SIGNAL
27	LG	COMMUNICATION SIGNAL (METER->AMP.)
28	R	VEHICLE SPEED (8-PULSE)
28	R	PARKING BRAKE SWITCH SIGNAL
30	V	COMMUNICATION SIGNAL (AMP->LCD)
34	B	BLOWER MOTOR CONTROL SIGNAL
38	P	

Connector No.	M67
Connector Name	UNIFIED METER AND A/C AMP.
Connector Type	TH432FW-NH

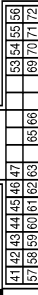

Terminal No.	Color of Wire	Signal Name [Specification]
41	BR	ACC POWER SUPPLY
42	BR	FUEL LEVEL SENSOR SIGNAL
43	R	INTAKE SENSOR SIGNAL
44	LG	IN-VEHICLE SENSOR SIGNAL
45	V	AMBIENT SENSOR SIGNAL
46	BG	SUNLOAD SENSOR SIGNAL
47	G	EXHAUST GASKET / OUTSIDE DOOR DETECTING SENSOR SIGNAL
53	W	IGNITION POWER SUPPLY
54	BG	BATTERY POWER SUPPLY
55	B	GROUND
56	L	CAN-H
57	LG	BRAKE FLUID LEVEL SWITCH SIGNAL
58	Y	FUEL LEVEL SENSOR SIGNAL GROUND
59	GR	INTAKE SENSOR SIGNAL GROUND
60	L	IN-VEHICLE SENSOR SIGNAL GROUND
61	R	AMBIENT SENSOR SIGNAL GROUND
62	SB	SUNLOAD SENSOR SIGNAL GROUND
63	L	ION CONTROL MODE OUTPUT SIGNAL
65	BG	ECV SIGNAL
69	L	A/C LAM SIGNAL
70	R	EACH DOOR MOTOR POWER SUPPLY
71	GR	GROUND
72	P	CAN-L

Connector No.	M107
Connector Name	ECM
Connector Type	RH24GY-R23-R-LH-Z

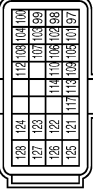

Terminal No.	Color of Wire	Signal Name [Specification]
97	R	APPE SEN 1
98	P	APPE SEN 2
99	L	SENSOR POWER SUPPLY
100	W	SENSOR GROUND
101	SB	ASCD/CC STEERING SW
102	G	EVAP CONTROL SYSTEM PRESS SEN
103	G	SENSOR POWER SUPPLY
104	GR	SENSOR GROUND
105	L	REFRIGERANT PRESS SEN
106	LG	FUEL TANK TEMP SEN
107	BR	SENSOR POWER SUPPLY
108	Y	SENSOR GROUND
109	G	PNP SIGNAL
110	BR	ENGINE SPEED OUTPUT SIGNAL
112	R	SENSOR GROUND
113	P	CAN COMMUNICATION LINE
114	L	CAN COMMUNICATION LINE
117	V	DATA LINK CONNECTOR
121	LG	EVAP CANISTER VENT CONTROL VALVE
122	P	STOP LAMP SW
123	B	ECM GROUND
124	B	ECM GROUND
125	R	POWER SUPPLY FOR ECM
126	BR	ASCD/CC BRAKE SW
127	B	ECM GROUND
128	B	ECM GROUND

A
B
C
D
E
F
H
I
J
K
L
M
N
O
P

STC

POWER STEERING CONTROL UNIT

< ECU DIAGNOSIS INFORMATION >

ELECTRONICALLY CONTROLLED POWER STEERING SYSTEM

Connector No.	M108	G	-
Connector Name	POWER STEERING CONTROL UNIT	Y	-
Connector Type	TH12EV-NH		

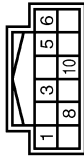

Terminal No.	Color of Wire	Signal Name [Specification]
1	LG	SOL
3	G	VIGN
5	GR	SOL GND
6	B	GND
8	L	VSP
10	BR	TACHO

Connector No.	M116
Connector Name	WIRE TO WIRE
Connector Type	TK38MW-MS10



Terminal No.	Color of Wire	Signal Name [Specification]
2	W	-
3	BG	-
4	R	-
5	B	-
9	R	-
10	R	-
19	BG	-
20	Y	-
28	GR	-
29	LG	-
30	LG	-
31	W	-
41	BG	-
42	G	-
43	P	-
44	L	-

JCGWM0488GB

INFOID:000000006469999

Fail-Safe

EPS system

POWER STEERING CONTROL UNIT

< ECU DIAGNOSIS INFORMATION >

- EPS system enters the fail-safe mode (that allows the steering force to be controlled without impairing the drivability) if any of the input/output values to/from EPS system (power steering control unit) deviate from the standard range.

NOTE:

The system enters the fail-safe mode if the engine speed remains at 1,500 rpm or more for over 10 seconds while the vehicle is stopped. This is normal.

- The fail-safe function is canceled when a vehicle speed signal of 2 km/h (1.2 MPH) or more is inputted or the ignition switch is turned OFF→ON. EPS system restores the normal operation at that time.

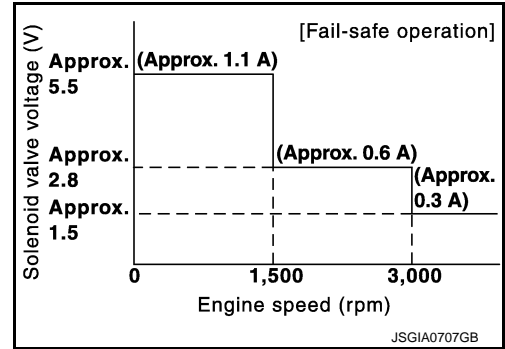

Mode	Warning lamp	DTC	Detection point (malfunction part)	Error area and root cause
Fail-safe	—	—	Vehicle speed signal input	<ul style="list-style-type: none"> • Engine speed is 1,500 rpm or more and there is no vehicle speed signal input for over 10 seconds during vehicle travel. • Vehicle speed signal has abruptly dropped from 30 km/h (19 MPH) or more to 2 km/h (1.2 MPH) or less within 1.4 seconds.

A
B
C
D
E
F
H
I
J
K
L
M
N
O
P

STC

UNBALANCE STEERING WHEEL TURNING FORCE (TORQUE VARIATION)

< SYMPTOM DIAGNOSIS >

SYMPTOM DIAGNOSIS

UNBALANCE STEERING WHEEL TURNING FORCE (TORQUE VARIATION)

Description

INFOID:000000006470000

- Hard steering when fully turning the steering wheel.
- Light steering when driving at a high speed.

Diagnosis Procedure

INFOID:000000006470001

1. CHECK SYSTEM FOR POWER SUPPLY AND GROUND

Perform trouble diagnosis for power supply and ground. Refer to [STC-6, "Diagnosis Procedure"](#).

Is the inspection result normal?

- YES >> GO TO 2.
- NO >> Repair or replace error-detected parts.

2. CHECK SYSTEM FOR VEHICLE SPEED SIGNAL

Perform trouble diagnosis for vehicle speed signal. Refer to [STC-11, "Diagnosis Procedure"](#).

Is the inspection result normal?

- YES >> GO TO 3.
- NO >> Repair or replace error-detected parts.

3. CHECK SYSTEM FOR ENGINE SPEED SIGNAL

Perform trouble diagnosis for engine speed signal. Refer to [STC-9, "Diagnosis Procedure"](#).

Is the inspection result normal?

- YES >> GO TO 4.
- NO >> Repair or replace error-detected parts.

4. CHECK SYSTEM FOR POWER STEERING SOLENOID VALVE

Perform trouble diagnosis for power steering solenoid valve. Refer to [STC-7, "Diagnosis Procedure"](#).

Is the inspection result normal?

- YES >> Perform the symptom diagnosis for the steering system. Refer to [ST-3, "NVH Troubleshooting Chart"](#).
- NO >> Repair or replace error-detected parts.

PRECAUTIONS

< PRECAUTION >

PRECAUTION

PRECAUTIONS

Precaution for Supplemental Restraint System (SRS) "AIR BAG" and "SEAT BELT PRE-TENSIONER"

INFOID:000000006470002

The Supplemental Restraint System such as "AIR BAG" and "SEAT BELT PRE-TENSIONER", used along with a front seat belt, helps to reduce the risk or severity of injury to the driver and front passenger for certain types of collision. This system includes seat belt switch inputs and dual stage front air bag modules. The SRS system uses the seat belt switches to determine the front air bag deployment, and may only deploy one front air bag, depending on the severity of a collision and whether the front occupants are belted or unbelted. Information necessary to service the system safely is included in the "SRS AIR BAG" and "SEAT BELT" of this Service Manual.

WARNING:

Always observe the following items for preventing accidental activation.

- To avoid rendering the SRS inoperative, which could increase the risk of personal injury or death in the event of a collision that would result in air bag inflation, all maintenance must be performed by an authorized NISSAN/INFINITI dealer.
- Improper maintenance, including incorrect removal and installation of the SRS, can lead to personal injury caused by unintentional activation of the system. For removal of Spiral Cable and Air Bag Module, see "SRS AIR BAG".
- Never use electrical test equipment on any circuit related to the SRS unless instructed to in this Service Manual. SRS wiring harnesses can be identified by yellow and/or orange harnesses or harness connectors.

PRECAUTIONS WHEN USING POWER TOOLS (AIR OR ELECTRIC) AND HAMMERS

WARNING:

Always observe the following items for preventing accidental activation.

- When working near the Air Bag Diagnosis Sensor Unit or other Air Bag System sensors with the ignition ON or engine running, never use air or electric power tools or strike near the sensor(s) with a hammer. Heavy vibration could activate the sensor(s) and deploy the air bag(s), possibly causing serious injury.
- When using air or electric power tools or hammers, always switch the ignition OFF, disconnect the battery, and wait at least 3 minutes before performing any service.

Precautions Necessary for Steering Wheel Rotation After Battery Disconnection

INFOID:000000006470003

CAUTION:

Comply with the following cautions to prevent any error and malfunction.

- Before removing and installing any control units, first turn the ignition switch to the LOCK position, then disconnect both battery cables.
- After finishing work, confirm that all control unit connectors are connected properly, then re-connect both battery cables.
- Always use CONSULT to perform self-diagnosis as a part of each function inspection after finishing work. If a DTC is detected, perform trouble diagnosis according to self-diagnosis results.

For vehicle with steering lock unit, if the battery is disconnected or discharged, the steering wheel will lock and cannot be turned.

If turning the steering wheel is required with the battery disconnected or discharged, follow the operation procedure below before starting the repair operation.

OPERATION PROCEDURE

1. Connect both battery cables.

NOTE:

Supply power using jumper cables if battery is discharged.

2. Turn the ignition switch to ACC position.
(At this time, the steering lock will be released.)
3. Disconnect both battery cables. The steering lock will remain released with both battery cables disconnected and the steering wheel can be turned.

PRECAUTIONS

< PRECAUTION >

4. Perform the necessary repair operation.
5. When the repair work is completed, re-connect both battery cables. With the brake pedal released, turn the ignition switch from ACC position to ON position, then to LOCK position. (The steering wheel will lock when the ignition switch is turned to LOCK position.)
6. Perform self-diagnosis check of all control units using CONSULT.

Service Procedure Precautions for Models with a Pop-up Roll Bar

INFOID:000000006470004

WARNING:

Always observe the following items for preventing accidental activation.

- Risk of passenger injury or death may increase if the pop-up roll bar does not deploy during a roll over collision. In order to reduce the chance of an incident where the pop-up roll bar is inoperative, all maintenance must be performed by a NISSAN or INFINITI dealer.
- Before removing and installing the pop-up roll bar component parts and harness, always turn the ignition switch OFF, disconnect the battery negative terminal, and wait for 3 minutes or more. (The purpose of this operation is to discharge electricity that is accumulated in the auxiliary power supply circuit in the air bag diagnosis sensor unit.)
- When repairing, removing, and installing a pop-up roll bar, always refer to SRS AIR BAG and SRS AIR BAG CONTROL warnings in the Service Manual.

Precaution for Battery Service

INFOID:000000006470005

Before disconnecting the battery, lower both the driver and passenger windows. This will prevent any interference between the window edge and the vehicle when the door is opened/closed. During normal operation, the window slightly raises and lowers automatically to prevent any window to vehicle interference. The automatic window function will not work with the battery disconnected.

POWER STEERING CONTROL UNIT

< REMOVAL AND INSTALLATION >

REMOVAL AND INSTALLATION

POWER STEERING CONTROL UNIT

Removal and Installation

INFOID:000000006470007

REMOVAL

1. Remove glove box assembly. Refer to [JP-12. "A/T MODELS : Exploded View"](#)(A/T models), [JP-23. "M/T MODELS : Exploded View"](#)(M/T models).
2. Remove power steering control unit screws.
3. Remove power steering control unit.
4. Disconnect power steering control unit connector.

INSTALLATION

Install in the reverse order of removal.

A
B
C
D
E
F
H
I
J
K
L
M
N
O
P

STC